

Edge of Arlington Saw & Tool, Inc.

124 South Collins
Arlington, TX 76010
Phone: 817-461-7171 • Fax: 817-795-6651
Toll Free: 888-461-7171
Email: info@eoasaw.com
Website: www.eoasaw.com

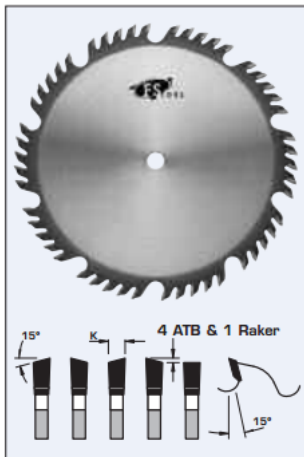

Item #L55225, FS Tool Industrial Quality Combination Saw Blades

\$128.11

Thank you for shopping with us!

Design:

- Tooth configuration: 4 ATB & 1 Raker
- Cutting Material: TC
- Four ATB teeth and one raker with a deep gullet allows deeper cuts and improved chip flow

Application:

- For crosscutting and ripping dry soft and hardwoods, plywood, and particleboard.
- On table saws, sliding table saws, and cut-off saws

SPECIFICATIONS

Diameter	9 in
Bore	5/8 in
Kerf	.125 in
Manufacturer	FS Tool
Plate	.087 in
Teeth	40