

Edge of Arlington Saw & Tool, Inc.

124 South Collins
Arlington, TX 76010
Phone: 817-461-7171 • Fax: 817-795-6651
Toll Free: 888-461-7171
Email: info@eoasaw.com
Website: www.eoasaw.com



Item #HO-164, Amana Tool BT 40 High Precision ER Collet 28mm Chuck Tool Holder (Industrial) \$114.84

Thank you for shopping with us!

- Amana Tool BT 40 High Precision ER Collet 28mm Chuck Tool Holder (Industrial)

CNC Replacement Parts

- Made from alloy steel hardened to 54 - 56rc
- Tool Holders Balanced to G2.5 at 25,000 RPMs
- Coolant thru capability
- Concentricity is less than .0002 at collet face
- Rear thread for pull stud is M16 x 2.0
- Spring collet not included

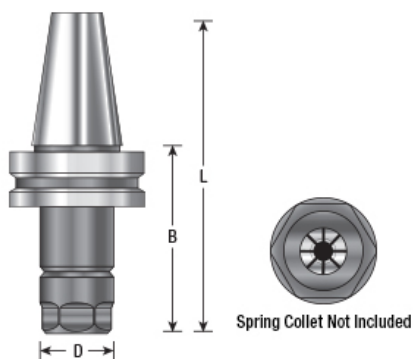

SPECIFICATIONS

Manufacturer	Amana Tool
Cut Height, Length, or Width	70 mm
Length	135.4 mm
Style	BT-40
Thread Size/Length	M16x2.0
Type	Collet ER16