



Straight Plunge



Trimming & Beveling



Grooving



Profiling



RABBETING



Jointing



Door Making



Solid Surface

# Router Bits



ROUTER BITS

## RABBET WITH BALL BEARING GUIDE

### 2 FLUTE

This is the basic rabbeting bit. It cuts 3/8" wide and up to 1/2" deep. Switch to one of four optional ball-bearing guides to alter the width of cut. Use in all handheld and table-mounted routers.

ØD	A	B	Tool No.	Ød	L
1-1/4	3/8	1/2	49300	1/4	2
<i>New</i> 1-1/8	3/8	1/2	RC-49300	1/4	1-7/8
1-1/4	3/8	1/2	49302	1/2	2-3/8

Replacement Knife #RCK-264 (2)

A	Replacement Bearings:
Standard . . . . . 3/8	Rabbet — 47706
OR . . . . . 7/16	Rabbet — 47702
OR . . . . . 5/16	Rabbet — 47718
OR . . . . . 1/4	Rabbet — 47720

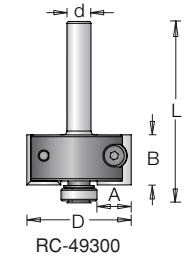
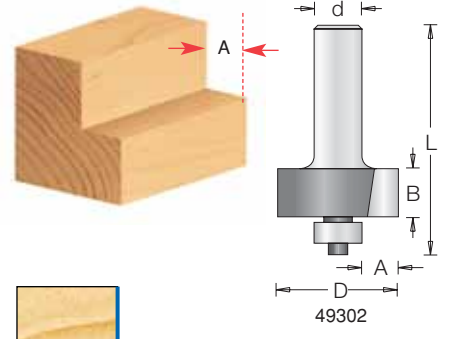

## MULTI-RABBET WITH BALL BEARING GUIDE

### 2 FLUTE

### SIX DIFFERENT RABBET DEPTHS

The Multi-Rabbet bit steps in 1/16" increments from a 1/8" cut width to 1/2", simply by switching ball-bearing guides. Six different bearings are provided. Depth of cut capacity of 1/2". Use in any handheld or table-mounted router.

ØD	A	Tool No.	B	Ød	L
1-3/8	1/8, 1/4, 5/16, 3/8, 7/16, 1/2	49340	1/2	1/4	2
1-3/8	1/8, 1/4, 5/16, 3/8, 7/16, 1/2	49350	1/2	1/2	2-3/8

A	Replacement Bearings:
1/2 Rabbet	— 47702
7/16 Rabbet	— 47706
3/8 Rabbet	— 47718
5/16 Rabbet	— 47720
1/4 Rabbet	— 47719
1/8 Rabbet	— 47743

#6000: Complete replacement kit including 6 bearings, hex key, washer & screw.

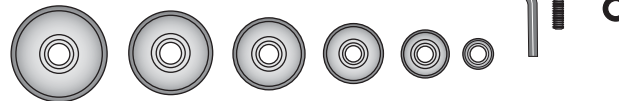

Screw #67094. Washer #67202.

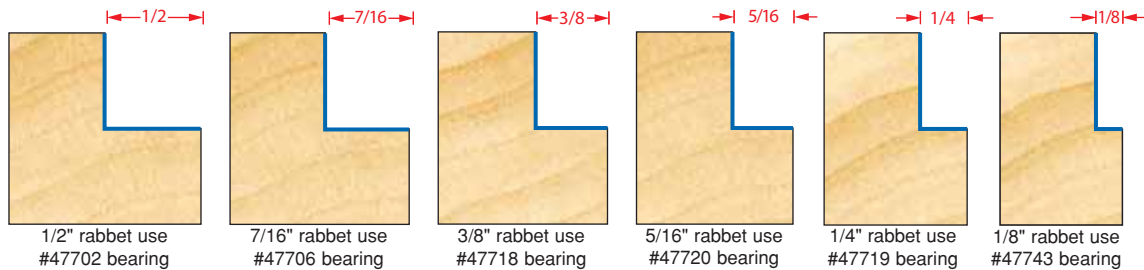
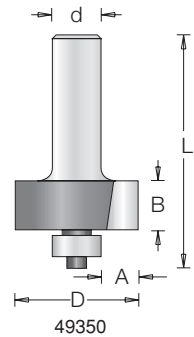

## SPECIAL RABBET WITH BALL BEARING GUIDE

### 2 FLUTE DEPTH OF RABBET 9/32"

Designed for the "smart clip" backslash system.

ØD	A	Tool No.	B	Ød	L
1-1/16	9/32	49310	7/8	1/2	2-5/8

Replacement bearing #47706.

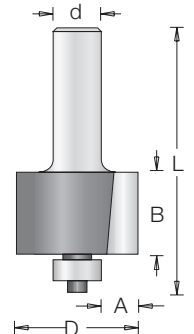

Wood profiles shown at actual size. 3D renderings & tool illustrations not shown at actual size. For additional 1:1 profiles and a complete replacement part listing visit [www.amanatool.com](http://www.amanatool.com)

# Router Bits



Straight Plunge



Trimming & Beveling



Grooving



Profiling



RABBETING



Jointing



Door Making



Solid Surface

ROUTER BITS

## INSERT SUPERRABBIT™ WITH BALL BEARING GUIDE

This ingenious tool features both interchangeable cutting edges and interchangeable guide collar, enabling it to cut a wide range of rabbets. Changing the collars on the twin ball-bearing guide steps the cut width in 1/16" increments from flush through 3/4" with five extra "plywood" sizes. Between the standard and optional collars, there are 18 different rabbet sizes available. The deep guide collar design adds stability to the tool for hand-held router operations. The basic 2" diameter bit includes a hex key, instructions, and all necessary parts for 5/8" and 3/4" width rabbets. The "RC" version has extra-long double-edged carbide inserts which enables the bit to cut as deep as 7/8". Inserts can be rotated or replaced without removing the bit from the router.

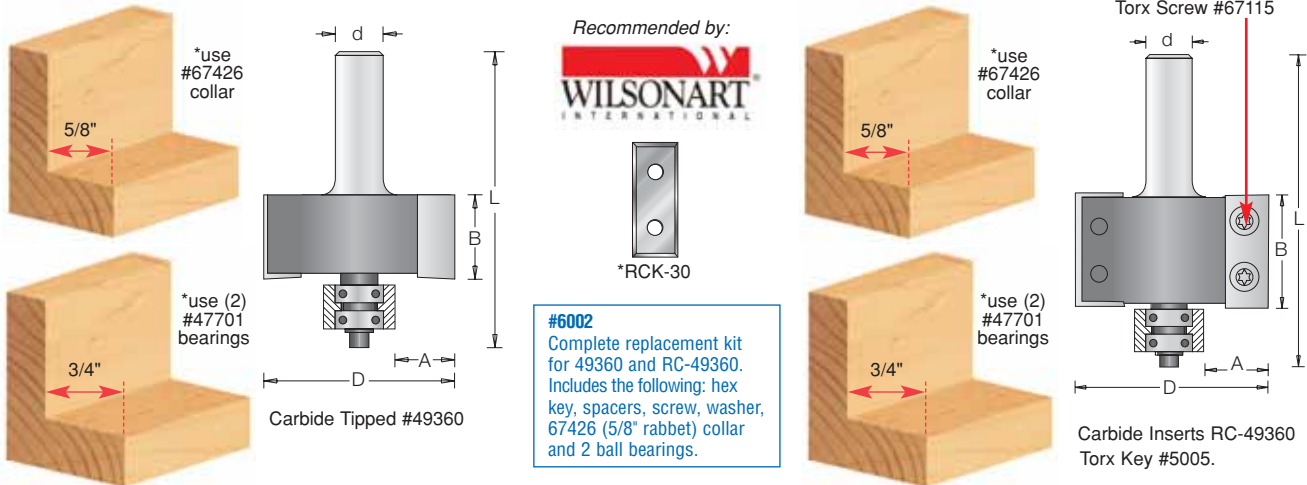

ØD	A	B	Tool No.	Ød	L
2	5/8 & 3/4	7/8	49360	1/2	3

ØD	A	B	Tool No.	Ød	L	Replacement Knives
2	5/8 & 3/4	30mm	RC-49360	1/2	3-3/8	*RCK-30

**WARNING:** Maximum RPM = 22,000

Replacement Screw for bearing #67094.  
Replacement Washer for bearing #67202.  
Replacement Spacer Bearing #67206.



Use in a table-mounted router.  
Not for use in a handheld router!

**WARNING:** Maximum RPM = 17,000

\*Standard general purpose replacement knives = #RCK-30;  
Knives also available for MDF & solid surface materials - in replacement carbide section.

## SUPERRABBIT™ ACCESSORIES

### COLLARS & COLLAR KITS

#### 67500

6-piece collar kit for 1/16", 1/8", 1/4", 3/8", 1/2" depth rabbets includes the following:

Order No.	Collar Dia.	'A' Rabbet Depth
67398	2	Flush
67400	1-7/8	1/16
67402	1-3/4	1/8
67408	1-1/2	1/4
67414	1-1/4	3/8
67420	1	1/2

#### 67600

5-piece collar kit for 3/16", 5/16", 7/16", 9/16", 11/16" depth rabbets includes the following:

Order No.	Collar Dia.	'A' Rabbet Depth
67404	1-5/8	3/16
67410	1-3/8	5/16
67416	1-1/8	7/16
67422	7/8	9/16
67428	5/8	11/16

#### 67700

5-piece collar kit for 15/64" (6mm), 23/64" (9mm), 15/32" (12mm), 19/32" (15mm) & 23/32" (18mm) rabbet depths includes the following:

Order No.	Collar Dia.	'A' Rabbet Depth
67406	1-17/32	15/64 (6mm)
67412	1-9/32	23/64 (9mm)
67418	1-1/16	15/32 (12mm)
67424	13/16	19/32 (15mm)
67430	9/16	23/32 (18mm)

#### 67800

21-piece Collar Kit including 16 individual collars shown above, 2 extra #47701 bearings, #67206 spacer, #5000 allen key and #67094 allen screw.

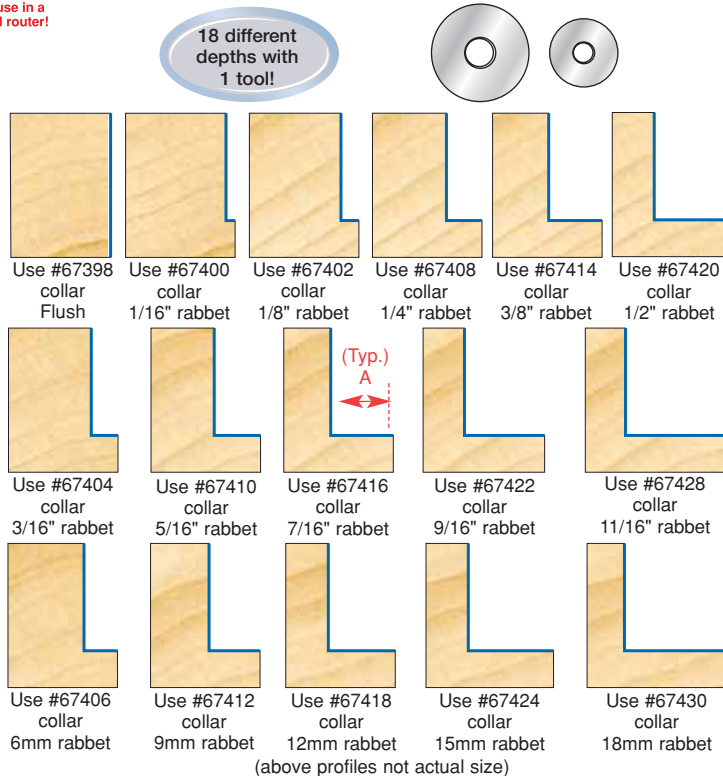

NOTE: 5/8" and 3/4" depth is standard with #49360 & RC-49360.

Wood profiles shown at actual size. 3D renderings & tool illustrations not shown at actual size. For additional 1:1 profiles and a complete replacement part listing visit [www.amanatool.com](http://www.amanatool.com)





Straight Plunge



Trimming & Beveling



Grooving



Profiling



RABBETING



Jointing



Door Making



Solid Surface

# Router Bits



## INSERT SUPERABBET, JR™ W/BALL BEARING GUIDE

### 2 FLUTE

A scaled-down version of the Superabbet™, this tool features four-sided replaceable carbide knives and a reduced cut depth capacity. It uses the same twin ball-bearing guide collar assortment to produce the same extensive range of precise rabbet widths. The standard tool is supplied with a collar for 1/2" rabbet width. Optional collars are available individually and in five-piece and 17-piece kits.

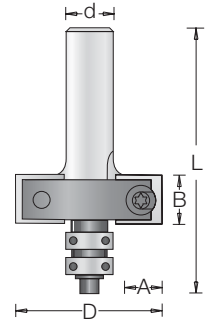
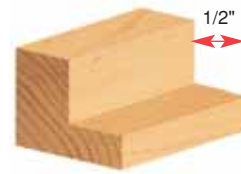

\*AMA-12

ØD	A	Tool No.	B	Ød	L
22 1-1/2	*Flush to 1/2"	RC-49355	12mm(.472)	1/2	3

\*Using optional collars below. Standard depth=1/2"  
Torx Key #5005. Torx Screw #67115.

**WARNING:** Maximum RPM  $\triangle$  = 22,000 Torx Key #5005.

\*Standard general purpose replacement knives = #AMA-12; Knives also available for MDF and solid surface materials - in replacement carbide section.



Individual Collars:		
Order No.	Collar ØDia.	'A' Rabbet Depth
67408	1-1/2	Flush
67410	1-3/8	1/16
67412	1-9/32	7/64
67414	1-1/4	1/8
67416	1-1/8	3/16
67418	1-1/16	7/32

Individual Collars:		
Order No.	Collar ØDia.	'A' Rabbet Depth
67420	1	1/4
67422	7/8	5/16
67424	13/16	11/32
67426	3/4	3/8
67428	5/8	7/16
67430	9/16	15/32

## SUPERABBET, JR™ ACCESSORIES

### #67350

5-piece collar kit for Flush, 1/16", 1/8", 1/4" and 3/8" depth rabbets.



### #67355

17-piece collar kit including all 12 individual collars, two #47701 bearings, #67206 spacer, #5000 allen key and #67094 allen screw.

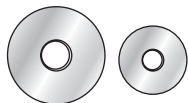

### COLLAR KITS

Torx Key #5005. Torx Screw #67115.



Use #67408 collar flush



Use #67410 collar 1/16" rabbet



Use #67412 collar 7/64" rabbet



Use #67414 collar 1/8" rabbet



Use #67416 collar 3/16" rabbet



Use #67418 collar 7/32" rabbet



Use #67420 collar 1/4" rabbet



Use #67422 collar 5/16" rabbet



Use #67424 collar 11/32" rabbet

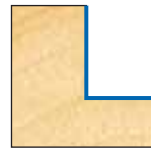

Use #67426 collar 3/8" rabbet

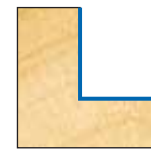

Use #67428 collar 7/16" rabbet



Use #67430 collar 15/32" rabbet