

Replacement Parts Index



REPLACEMENT PARTS

TOOL NO.	PAGE #	BEARING(S)	SET SCREW	SCREW	DUST SHIELD	FLAT WASHER	LOCK WASHER	COLLAR W/ SET SCREW	COLLAR SET SCREW ONLY	SNAP RING	HEX NUT
44100	16	47706	-	-	67098	-	-	-	-	-	67086
45360 to 45364	23	47721	-	-	-	-	-	47739	-	-	-
45460(S) to 45461	22	47701	-	-	-	-	-	47724	67091	-	-
45462(S)	22	47712	-	-	-	-	-	47724	67091	-	-
45463	22	47721	-	-	-	-	-	47739	67091	-	-
45464(S)	22	47714	-	-	-	-	-	47724	67091	-	-
45465	22	47721	-	-	-	-	-	47739	67091	-	-
45466	22	47722	-	-	-	-	-	47730	67091	-	-
45467	22	47754	-	-	-	-	-	47739	67091	-	-
45468	22	47738	-	-	-	-	-	47740	67091	-	-
45469 to 45470	77	47712	-	-	-	-	-	-	-	-	-
45471	77	46641	-	-	-	-	-	-	-	-	-
45474	77	47712	-	-	-	-	-	-	-	-	-
45476 to 45479	77	47712	-	-	-	-	-	-	-	-	-
45482 to 45483	22	47712	-	-	-	-	-	47724	67091	47752	-
45485	22	47714	-	-	-	-	-	47724	67091	-	-
45561	21	47714	-	-	-	-	-	47724	67091	-	-
45563	21	47721	-	-	-	-	-	47740	67091	-	-
45565	21	47754	-	-	-	-	-	47740	67091	-	-
45567	21	47758	-	-	-	-	-	47740	67091	-	-
45582	21	47701	-	-	-	-	-	47724	67091	-	-
45584	21	47712	-	-	-	-	-	47724	67091	-	-
45586	21	47714	-	-	-	-	-	47724	67091	-	-
45588 to 45590	21	47756	-	-	-	-	-	47740	67091	-	-
45668, 45676	88	47701	-	-	-	-	-	47724	-	-	-
45669,45670,45672,45678	88	47712	-	-	-	-	-	47724	-	-	-
45674	88	47708	-	-	-	-	-	47724	-	-	-
45750 to 45950	36	47701	-	-	-	-	-	47724	-	-	-
45788	37	47738	-	-	-	-	-	47740	-	-	-
45850	76	47701	-	-	-	-	-	47724	-	-	-
45880 to 45882	77	47712	-	-	-	-	-	-	-	-	-
45884	77	47741	-	-	-	-	-	-	-	-	-
45983	38	47701	-	-	-	-	-	47724	67091	-	-
45988	38	47714	-	-	-	-	-	47724	67091	-	-
45990	38	47721	-	-	-	-	-	47739	67091	-	-
45992	38	47738	-	-	-	-	-	47740	67091	-	-
46192	26	47706	-	-	-	-	-	-	-	-	67086
46300 to 46304	26,106	47706 (2)	-	67096	67098	-	-	-	-	-	67086
47090 to 47092	24	47723	-	67134	-	-	-	-	-	-	-
47100 to 47102	24	47702	-	67096	67100	67202	-	-	-	-	-
47104 to 47120	24	47706	-	67096	67098	67202	-	-	-	-	-
47105,47109,47111,47113	25	47706	-	-	-	-	-	-	-	-	-
47124 to 47128	25	47706	-	67109	67078	67101	-	-	-	-	-
47129	25	47706	-	-	-	-	-	-	-	-	-
47124-2 to 47128-2	25	47706 (2)	-	-	67098	67202	-	-	-	-	67118
47130 to 47138	25	47714	-	-	-	-	-	-	-	-	-
47140 to 47141	24	47714	-	67109	67101	-	-	-	-	-	-
47144	18	47706	-	67096	67098	67202	-	-	-	-	-
47150 to 47154	29	47704	-	67095	67100	67124	-	-	-	-	-
47160 to 47162	30	47706	-	-	-	-	-	-	-	-	-
47180	25	47712	-	67109	-	67101	-	-	-	-	-
47182 to 47184	25	47714	-	67109	-	67101	-	-	-	-	-
47190 to 47194	30	47718	-	67096	67098	67101	-	-	-	-	-
47200 to 47204	30	47706	-	67096	67098	67202	-	-	-	-	-
47206	30	47704	-	67096	67100	67082	-	-	-	-	-
47210	31	47706	-	67096	67098	67202	-	-	-	-	-
47300 to 47304	31	47716	-	67096	67098	67202	-	-	-	-	-
47400 to 47416	32	47708	-	-	-	67204	-	-	-	-	67088
49092 to 49119	52	47704	-	67095	67100	67200	-	-	-	-	-
49120 to 49122	52	47706	-	67096	67098	67202	-	-	-	-	-
49150 to 49154	51	47712 (2)	-	67109	-	67101	-	-	-	47748	-
49200 to 49206	55	47704	-	-	-	-	-	-	-	-	-
49207	55	47704	-	-	-	-	-	-	-	-	-
49208 to 49214	56	47704	-	67095	67100	67200	-	-	-	-	-
49300 to 49302	70	47706	-	67096	67098	67202	-	-	-	-	-
49310	71	47706	-	-	-	-	-	-	-	-	-
49340 to 49350	71	See Page	-	-	-	-	-	-	-	-	-
49360	72	47701 (2)	-	67094	-	67202	-	-	-	-	-
49400 to 49402	45	47704	-	67095	67100	67200	-	-	-	-	-
49404	45	47706	-	67096	67098	67202	-	-	-	-	-
49405	45	47710	-	67093	-	67101	-	-	-	-	-
49406 to 49410	45	47706	-	67096	67098	67202	-	-	-	-	-
49412	45	47704	-	67095	67100	67200	-	-	-	-	-
49414 to 49416	45	47706	-	67096	67098	67202	-	-	-	-	-
49440, 49450	94	47702	-	67096	67101	67202	-	-	-	-	-
49442, 49452	94	47701	-	-	-	-	-	47724	67091	-	-
49492 to 49526	47	47706	-	67096	67098	67202	-	-	-	-	-
49540 to 49560	68	47706	-	67096	67098	67202	-	-	-	-	-
49562	102	47706	-	67096	67098	67202	-	-	-	-	-
49592 to 49622	48	47702	-	67096	67101	67202	-	-	-	-	-
49640, 49644, 49650	94	47702	-	67096	67101	67202	-	-	-	-	-
49642, 49646, 49652	94	47701	-	-	-	-	-	47724	67091	-	-
49660, 49664	94	47702	-	67096	67101	67202	-	-	-	-	-
49662, 49666	94	47701	-	-	-	-	-	47724	67091	-	-
49670, 49674	94	47702	-	67096	67101	67202	-	-	-	-	-
49672, 49676	94	47701	-	-	-	-	-	47724	67091	-	-
49730	45	47708	-	-	-	-	-	-	-	-	67088
49750 to 49760	46	47736	-	-	-	-	-	-	-	-	67088
49770	46	47708	-	-	-	-	-	-	-	-	67088
51530 to 51534	50	47716	-	67096	67098	67202	-	-	-	-	-
51565 to 51570	49	47706	-	67096	67098	67202	-	-	-	-	-
51572	49	47716	-	67096	67098	67202	-	-	-	-	-
51574 to 51576	49	47714	-	67093	67126	-	-	-	-	-	-
51592	50	47738	-	-	-	-	-	47740	67091	-	-
53600	80	47708	-	67022	-	-	-	-	-	-	-
53610	81	47708	-	-	-	-	-	-	-	-	67088
53620 to 53640	81	47736	-	-	-	-	-	-	-	-	67088
54102 to 54108	53	47706	-	67096	67098	67202	-	-	-	-	-
54115 to 54116, 54119	98	47706	-	-	-	-	-	-	-	-	-
54117 to 54118, 54121	97	47706	-	67096	67098	67202	-	-	-	-	-
54120 to 54127	55	47706	-	67096	67098	67202	-	-	-	-	-
54128 to 54135	53	47706	-	67096	67098	67202	-	-	-	-	-
54136 to 54182	54	47706	-	-	-	-	-	-	-	-	-
54144 to 54150	52	47706	-	-	-	-	-	-	-	-	-
54152 to 54158	51	47706	-	67096	67098	67202	-	-	-	-	-

Replacement Parts Index



TOOL NO.	PAGE #	BEARING(S)	SET SCREW	SCREW	DUST SHIELD	FLAT WASHER	LOCK WASHER	COLLAR W/ SET SCREW	COLLAR SET SCREW ONLY	SNAP RING	HEX NUT
54160 to 54162	56	47706	-	67096	67098	67202	-	-	-	-	-
54164 to 54172	56	47716	-	67096	67098	67202	-	-	-	-	-
54180 to 54182	54	47706	-	67096	67098	67202	-	-	-	-	-
54184 to 54186	57	47706	-	67096	67098	67202	-	-	-	-	-
54188	57	47716	-	67096	67098	67082	-	-	-	-	-
54190 to 54194	56	47712 (2)	-	67109	-	-	-	47724	67091	-	-
54198	67	47702	-	67096	-	67100	-	-	-	-	-
54200	67	47706	-	67096	-	67100	-	-	-	-	-
54202 to 54204	62	47706	-	67096	-	67202	-	-	-	-	-
54211 to 54217	60	47716	-	67096	67103	67202	-	-	-	-	-
54218 to 54220	62	47706	-	67096	67098	67202	-	-	-	-	-
54221	99	47713, 47763	-	-	-	-	-	-	-	-	67088
54222 to 54226	63	47706	-	67096	67098	67202	-	-	-	-	-
54227	99	47713, 47763	-	-	-	-	-	-	-	-	67088
54228	63	47706	-	67096	67098	67202	-	-	-	-	-
54229	99	47713, 47763	-	-	-	-	-	-	-	-	67088
54230 to 54232	65	47712	-	-	-	-	-	-	-	-	-
54234 to 54238	64	47716	-	67096	67103	67202	-	-	-	-	-
54240	64	47706	-	67096	67103	67202	-	-	-	-	-
54260, 54266	65	47706	-	67096	67098	67202	-	-	-	-	-
54262	69	47706	-	67096	67098	67202	-	-	-	-	-
54268 to 54269	69	47716	-	67096	67103	67202	-	-	-	-	-
54280	65	47716	-	67096	67103	67202	-	-	-	-	-
54282	66	47714	-	67109	-	67101	-	-	-	-	-
54284 to 54286	66	47712	-	67096	67103	67202	-	-	-	-	-
54288 to 54290	66	47706	-	67096	67098	67202	-	-	-	-	-
54292	53	47706	-	67096	67098	67202	-	-	-	-	-
54294	59	47716	-	67096	67098	67202	-	-	-	-	-
54296	58	47712 (2)	-	67096	67098	67202	-	47724	-	-	-
54300 to 54308	59	47706	-	67096	67098	67202	-	-	-	-	-
54320 to 54322	58	47706	-	67096	67098	67202	-	-	-	-	-
54324	58	47712	-	67096	67103	67202	-	-	-	-	-
54330 to 54332	59	47701, 47706	-	67096	67098	67202	-	47724	-	-	-
54350 to 54356	60	47716	-	67096	67103	67202	-	-	-	-	-
55312 to 55314	31	47727	-	-	-	67204	-	-	-	-	67088
55320 to 55330	87	47708, 47762	-	-	-	-	-	-	-	-	67088
55340	89	47708	-	-	-	-	-	-	-	-	67088
55350 to 55380	93	47708	-	-	-	-	-	-	-	-	67088
55392	82	47736	-	-	-	-	-	-	-	-	67088
55400, 55401	86	47708 (2)	-	-	-	-	-	-	-	-	67088
55420, 55430, 55440	91	47708	-	-	-	-	-	-	-	-	67088
55421, 55431, 55441	92	47708	-	-	-	-	-	-	-	-	67088
55433, 55436, 55437	90	47708	-	-	-	-	-	-	-	-	67088
55460, 55462, 55464	96	47744(2)	-	-	67125(2)	-	-	-	-	-	67131
56130	44	47708	-	-	-	-	-	-	-	47748	-
56140	44	47734	-	-	-	-	-	-	-	47750	-
56148	44	47708	-	-	-	-	-	67091	-	47748	-
56150	44	47734	-	-	-	-	-	67091	-	47750	-
56154	44	47721	-	-	-	-	-	-	-	47748	-
56156	44	47738	-	-	-	-	-	-	-	47750	-
56158	44	47734	-	-	-	-	-	-	-	47750	-
56190	41	47701	-	-	-	-	-	47724	67091	-	-
56192	41	47714	-	-	-	-	-	47724	67091	-	-
56194	41	47708	-	-	-	-	-	47724	67091	-	-
56196 to 56198	41	47738	-	-	-	-	-	47740	67091	-	-
57100 to 57112	108	47714, 47712, 47701	-	67109	-	67101	-	-	-	-	-
57118 to 57120	104	47709	-	67109	-	67101	-	-	-	-	-
57122 to 57126	110	47726	-	67109	67126	67101	-	-	-	-	-
57127	109	47707	-	67096	-	67202	67101	-	-	-	-
57128	110	47726	-	67109	-	67101	-	-	-	-	-
57129	112	47732	-	67146	-	-	-	-	-	-	-
57130	110	47726	-	67093	67126	67126	-	-	-	-	-
57138, 57140	105	47737	-	67091	-	-	-	47740	67091	-	-
57139, 57141	105	47707	-	67096	-	67202	-	-	-	-	-
57142 to 57144	112	47738	-	67091	-	-	-	47740	67091	-	-
57145	105	47737	-	-	-	-	-	47740	67091	-	-
57146, 57148	104	47707	-	67096	67098	67202	-	-	-	-	-
57147, 57149 to 57152	105	-	-	-	-	-	-	-	-	-	-
57153	106	47726	-	67109	67103	67101	-	-	-	-	-
57154	106	47709	-	-	-	-	-	-	-	-	-
57155	106	47133	-	67146	-	67101	-	-	-	-	-
57156 to 57160, 57162	111	47731	-	67146	-	-	-	-	-	-	-
57161	112	47732	-	67146	-	-	-	-	-	-	-
57164	108	47709	-	67146	-	67101	-	-	-	-	-
57165	107	47745, 47747	-	-	-	55371	-	47739	-	-	-
57166	107	47749	-	-	-	55363	-	47739	-	-	-
57167	112	47732	-	67146	-	-	-	-	-	-	-
57168	111	47731	-	67146	-	-	-	-	-	-	-
57184 to 57186	24, 106	47714	-	67109	67116	-	67128	-	-	-	-
57190	48, 105	47767	-	67109	-	67101	-	-	-	-	-
57192	48, 105	47768	-	67109	-	67101	-	-	-	-	-
57194	48, 105	47769	-	67109	-	67101	-	-	-	-	-
57200 to 57204	114	47709	-	67109	67116	67101	-	-	-	-	-
57212 to 57216	116	-	-	-	-	-	-	-	-	-	-
57218	117	-	-	-	-	-	-	-	-	-	-
57220	117	47707	-	67096	-	67202	-	-	-	-	-
57224	111	47726	-	67109	67126	67101	-	-	-	-	-
57226	113	47712	-	67096	67103	67202	-	-	-	-	-
57232	109	47737	-	-	-	-	-	47740	-	-	-
57234	109	47707	-	67096	-	67082	-	-	-	-	-
57238	117	47712	-	67096	67103	67202	-	-	-	-	-
57240 to 57242	118	47707	-	67096	-	67082	-	-	-	-	-
57244 to 57246	119	47707	-	67096	-	67082	-	-	-	-	-
57248	119	47709	-	67109	67116	67101	-	-	-	-	-
57252 to 57256	120	47707	-	-	-	-	-	-	-	-	-
57257	121	-	-	-	-	-	-	-	-	-	-
57258	117	47707	-	67096	-	67082	-	-	-	-	-
RC-1000 to RC-1006	27	47711	-	67176 (3)	-	-	-	-	-	-	-
RC-1008 to RC-1012	27	47712	-	67176 (3)	-	-	-	-	-	-	-
RC-1014	27	47701	-	67176 (3)	-	-	-	-	-	-	-
RC-1230	23	-	-	-	-	-	-	-	-	-	-
RC-2000	27	47706	67016 (2)	67018	-	-	-	-	-	-	-
RC-2400	23	-	-	-	-	-	-	-	-	-	-
RC-49355	73	See Page	67094	67094	-	67202	-	-	-	-	-
RC-49360	72	See Page	-	67094	-	67202	-	-	-	-	-

Replacement Parts

STEEL BALL BEARING GUIDES



Amana Tool® uses only the finest industrial quality precision ball bearings available. Bearings are double steel-shielded for extra rigidity and to inhibit dust. A special high-performance, high-temperature grease is used for maximum life.

Bearing #'s 47701-HP, 47706-HP and 47712-HP have Teflon® shields which provide a better seal and increased bearing life while routing materials that generate very fine dust particles (such as solid surface).

NOTE: Solvents should not be used to clean ball bearings, as this will deteriorate the special grease. 'Frozen' bearings (ones that do not rotate freely), should be replaced immediately.

FRACTIONAL LISTED BY SIZE/STEEL SHIELDS & NEW TEFLON® SHIELDS

Ød	ØD	B	Tool No.	Application
1/8	1/4	.110 (7/64)	47723	47090, 47092 1/4" diameter trim bits.
1/8	3/8	.155 (5/32)	47704	47206, 49400, 49402, smaller cove bits, several types of form bits, and old style 3/8" diameter trim bits, new 'no-file' trim bits.
1/8	1/2	.171 (11/64)	47700	Old style 1/2" diameter flush trim bits.
3/16	3/8	.124 (1/8)	47702	3/8" diameter flush trim, all beading bits, (49300/49302), 49340, 49350, 49540, 49542, 49550, many types of form bits.
3/16	1/2	.195 (3/16)	47706	Our most popular bearing. Fits 1/2" diameter flush trim, some bevel trim, all corner rounds, raised panel, rabbet, ovolo, many types of form bits and 51570, 54160, 54162, 54198, 54370 & new style 54200 & 54220 (after 12/95).
3/16	1/2	.195 (3/16)	*47706-HP	*With Teflon® dust shields used as a substitute for 47706 (see above) for fine dust conditions.
3/16	.490	.195 (3/16)	47715	New undersized 1/2" diameter bearing for use after resharpening. Fits all tools such as flush trims, corner rounds, etc., that use the standard 47706 bearing.
3/16	5/8	.195 (3/16)	47718	'Overhang' bits, 49340, 49350 (49300/49302).
3/16	3/4	.280 (9/32)	47720	(49300/49302), 49340, 49350, RC-4950
3/16	7/8	.196 (3/16)	47719	49340, 49350 for 1/4" rabbet.
3/16	1-1/8	.312 (5/16)	47743	49340, 49350 for 1/8" rabbet.
1/4	3/8	.124 (1/8)	47751	45475, 45475-S
1/4	1/2	.186 (3/16)	47701	45460, 45461, 45750, 45850, 45950, 57100, 57106, 57112, RC-1014.
1/4	1/2	.186 (3/16)	*47701-HP	*With Teflon® dust shields used as a substitute for 47701 (see above) for fine dust conditions.
1/4	5/8	.195 (3/16)	47712	45462, 45476, 45478, 45479, 45809, 45811, 47180, 51530, 51532, 51534, 54188, 54190, 54192, 54194, 54296, 54324, 54350, 54352, 54354, 54356, 57100, 57106, 57112, 'RC' series bevel trim bits.
1/4	5/8	.195 (3/16)	*47712-HP	*With Teflon® dust shields used as a substitute for 47712 (see above) for fine dust conditions.
1/4	3/4	.280 (9/32)	47714	45464, 45988, 47140, 47182, 47184, 51574, 51576, 57100, 57106, 57112, and old style 57118, 57120.
1/4	1	.344 (11/32)	47710	49405
5/16	3/4	.280 (9/32)	47759	55360
5/16	.865 (7/8)	.275 (9/32)	47708	1/2" depth of cut slotting assemblies, all stile & rail, 49730, 49770, 53610 55400, 55401, 56148, 55340.
5/16	1-1/4	.196	47763	New raised panel with back cutter 54221, 54227, 54229.
5/16	1.319 (1-5/16)	.335 (21/64)	47762	55320, 55330, 55325
3/8	7/8	7mm	47741	For 45884, 45499
1/2	3/4	.156 (5/32)	47721	45463, 45465, 45990
1/2	1-1/8	.312 (5/16)	47738	45468, 45789, 45992, 51590, 57142, 57144 and old style 57138 & 57140 (prior to 6/95). For new style 57138 & 57140 (after 6/95) use Ultra-Glide™ 47737.
1/2	1	5.7mm	47745	57165
1/2	1-1/4	5.7mm	47747	57165
1/2	1-1/2	.500 (1/2)	47749	57166

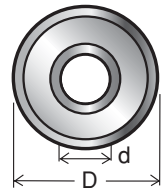

NOTE: Fractional size specifications shown in parentheses () are approximate, and are provided for reference purposes only. Tool numbers shown in parentheses () exhibit optional (not standard) bearings for these tools.

METRIC LISTED BY SIZE/STEEL SHIELDS

Ød	ØD	B	Tool No.	Application
4MM	8MM	3MM (7/64)	47703	New miniature router bits.
5mm	13mm	4mm (5/32)	47705	Old Style (Prior to 12/95) 54200, 54220. For new style (after 12/95) use 47706.
5mm	16mm	5mm (3/16)	47716	47300, 47302, 51572, 54164 through 54172, 54215, 54217, 54268, 54269, 54294, 57188, RC-4952, RC-4954, RC-4956.
6mm	19mm	6mm (15/64)	47711	'RC' series flush trim bits.
7mm	14mm	5mm (3/16)	47746	RC-1040, RC-1042, RC-1044
8mm	16mm	5mm (3/16)	47713	New raised panel with back cutter 54221, 54227, 54229.
8mm	28mm	9mm (23/64)	47736	49750, 55392
10mm	26mm	8mm (5/16)	47722	45466
12mm	32mm	9.9mm	47744	55460, 55462, 55464
15mm	35mm	11mm (7/16)	47734	56140, 56150, 56158
15mm	1	.218 (7/32)	47754	45467
15mm	1-1/4	.343 (11/32)	47756	45469
15mm	1-1/2	.343 (11/32)	47758	45470

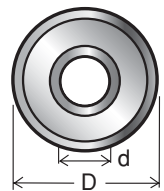

* Teflon® is a registered trademark of the Dupont Co.

Replacement Parts



ULTRA-GLIDE™ HIGH-PERFORMANCE BALL BEARING GUIDE ASSEMBLIES



Using the same quality standards as our regular steel bearings, these Ultra-Glide™ bearing assemblies feature satin-smooth Delrin® sleeves. Delrin® is an industrial synthetic plastic material similar to nylon, and will leave no marks on the material being cut. Applications include solid-surface materials such as Gibraltar®, Corian®, Surell® & Fountainhead®. etc.; Plexiglas® & other clear acrylics; and plastic laminates. Not recommended for regular wood applications due to a higher wear factor. Product #'s 47709, 47725, 47726, 47731 & 47733 now include new Teflon® dust shields. These bearings provide a better seal to increase bearing life while routing materials that generate very fine dust particles (such as solid surface).

Ød	ØD	Taper/R	Tool No.	Application
3/16	.500 (1/2)	-0-	47707	1/2" diameter flush trim, corner rounds, etc. All tools that accept our regular #47706 steel bearing.
1/4	.750 (3/4)	-0-	*47709	47140, 57154 trim bits, and new style 57118, 57120, 57257.
5/16	1.382 (1-3/8)	-0-	47727	Slot cutter assemblies: 1/4" depth of cut; and 53610.
5/16	1.137 (1-9/64)	-0-	47728	Slot cutter assemblies: 3/8" depth of cut; and 53610.
5/16		-0-	47729	Set of two above: 47727 & 47728.
1/4	.965 (31/32)	10°	*47725	Old style 57122 bevel bit with 31/32" large diameter.
1/4	.866 (7/8)	10°	*47726	New style 57122 and other 'solid-surface' type bits.
1/4	.866 (7/8)	10°	*47731	57156 through 57168 bowl bits only.
1/4	1	12°	*47732	57129 and 57161
1/4	1	5°	*47733	New bowl bits.
15mm	1.125 (1-1/8)	-0-	47737	New style 57138, 57140 (after 6/95). Old style use 47738.
1/4	27/32	1/2	47767	57190
1/4	3/4	3/4	47768	57192
1/4	3/4	1	47769	57194

NOTE: Outside dimensions are approximate and are given for reference purposes only.

* Includes new Teflon® dust shields.

Gibraltar® is a registered trademark of Wilsonart® International. Delrin®, Corian® and Teflon® are registered trademarks of the Dupont Co. Surell® is a registered trademark of the Formica Corp. Fountainhead® is a registered trademark of the Nevamar Corp. Plexiglas® is a registered trademark of the Rohm & Haas Corp.

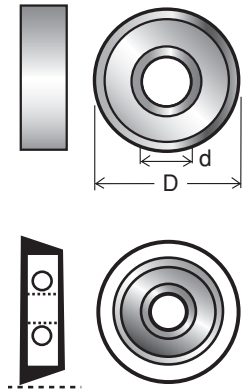

REPLACEMENT PARTS

ROUTER ARBORS WITH HEX NUT AND WASHERS

ØD	Ød	A	B	Tool No.	C	Application
5/16-24 NF	1/4	1-1/4	7/8	47600	2-3/8	} 2 & 3-Wing slotting assemblies, and single 4-wing trim cutter assemblies.
5/16-24 NF	3/8	1-1/4	7/8	47602	2-3/8	
5/16-24 NF	1/2	1-1/2	7/8	47604	2-3/8	
5/16-24 NF	1/4	1-1/4	5/8	47606	2-1/8	Shorter length than 47600.
5/16-24 NF	1/2	1-1/2	1-3/8	47612	3-1/8	Double trim cutters, rail & stile, 53600, 55300, 55320, 55325, 55330, 55400. (Replaces 55360 arbor.)
5/16-24 NF	1/2	1-7/16	2-9/16	47618	4-3/16	49730, 49770
5/16-24 NF	1/2	1-3/8	2-1/8	47620	3-3/4	49750, 55340, 55392
5/16-24 NF	1/2	1-5/16	1-3/4	47622	3-5/16	55420, 55430, 55440
1/4-28 NF	1/4	1-1/4	7/8	47610	2-3/8	General purpose.
1/4-28 NF	1/4	1-7/16	1/4	*47611	1-13/16	Screw Type mortising bits 55250 through 55258.
1/4-28 NF	1/2	1-3/4	1/4	*47614	1-1/2	Screw Type mortising bits 55250 through 55258.

*Due to application, these arbors are not furnished with hex nut or washers.

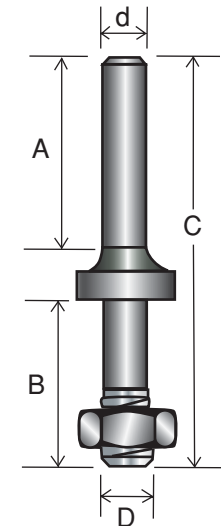

HEX NUTS FOR ROUTER ARBORS

Description	Tool No.	Application
10-32 NF	67086	46300, 46304 Spiral Trim bits.
5/16-24 NF	67088	All arbors with 5/16-24 NF thread.
1/4-28 NF	67089	47610 arbor. "Nova"
5mm x .8mm (10-32)	67118	47124-2, 47126-2, 47128-2 Trim bits.
12mm x 1.75mm	67131	55460, 55462, 55464





Replacement Parts

STEEL DUST SHIELDS

Application: Used between ball bearing and router bit to inhibit dust. 'Cone-shaped' end always faces the bearing.

Diameters		
'd' Inside x 'D' Outside	Tool No.	Use with Bearing #
3/16 x 1/2	67098	47700, 47701, 47706, 47712, 47714, 47718, 47720.
1/8 x 3/8	67100	47704
5mm x 16mm	67103	47716
1/4 x 5/8	67116	47712 (Solid surface bowl bits only).
3/16 x 5/8	67126	47712 (Solid surface bowl bits only).

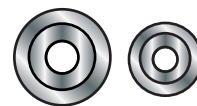

STEEL FLAT LOCK WASHERS

Application: Used between ball bearing & screw head or hex nut to serve as a lock washer. Part No. 67101 is used in place of a dust shield on beading bits #'s 49592 through 49622.

Diameters			
'd' Inside x 'D' Outside	Tool No.	Use with Bearing #	Use with Screw #
1/8 x 1/4	67082	47703	67080
3/16 x 5/16	67101	47702	67094, 69096
12mm x 18.7mm	67125	47744	55460, 55462, 55464
12mm x 18.7mm	67128	47714	57184 - 57186
1/4 x 3/8	67132	47701	'Face Inlay' spacer.
3/32 x 1/4	67200	47704	67095
1/8 x 5/16	67202	47706	67094, 67096
5/16 x 1/2	67204	47708	5/16 thread arbors (for slot cutters).
1/4 x .356	67206	47701	'Superabbet' spacer.

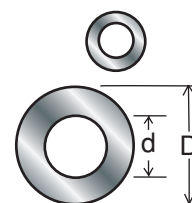

STEEL SPACERS

Application: General purpose arbor spacers used on assembly type tools that require cutter adjustment.

Diameters		
'd' Inside x 'D' Outside	Tool No.	'B' Face Width
5/16 x 5/8	55366	3.0mm (1/8)
5/16 x 5/8	55367	3.4mm (9/64)
5/16 x 5/8	55368	6.0mm (1/4)
5/16 x 5/8	55369	5.5mm (7/32)
1/2 x 3/4	55363	6.0mm (1/4)
1/2 x 18mm	55371	5.0mm

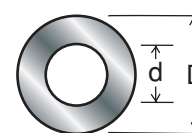

8 PIECE SPACER SET

New

Diameters				
'd' Inside x 'D' Outside	Tool No.	'B' Shim Thickness	Description	Qty.
1-1/4 x 1-31/32	67208	7.1mm (.2797)	0.1mm (.0040)	2pc.
			0.2mm (.0078)	2pc.
			0.5mm (.0197)	1pc.
			1.0mm (.0393)	1pc.
			2.0mm (.0788)	1pc.
			3.0mm (.1182)	1pc.

STEEL SHIMS

Application: General purpose arbor shims used on assembly type tools that require cutter adjustment. Particularly useful after tool re-sharpening.

Diameters		
'd' Inside x 'D' Outside	Tool No.	'B' Shim Thickness
5/16 x 5/8	55356	.05mm (.002)
5/16 x 5/8	55357	.10mm (.004)
32mm x 3/4	55358	.18mm (.007)
5/16 x 5/8	55402	1.00mm (.040)
5/16 x 5/8	55404	.50mm (.020)
5/16 x 5/8	55403	.40mm (.015)

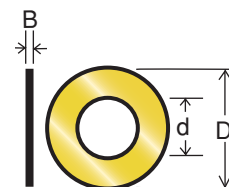



BALL BEARING RETAINING COLLARS AND SNAP RINGS

Application: To retain bearings on tools furnished with upper ball bearing guides.
Collars include #67091 set screw.

Diameters		
'd' Inside x 'D' Outside	Tool No.	Used On Tool No. ('s)
.289 x .375	47748	56130, 56148, 49150, 49152, 49154
.542 x .675	47750	56140, 56150



Snap Rings

Diameters		Face	
'd' Inside x 'D' Outside	Tool No.	Thickness	Used On Tool No. ('s)
1/4 x 7/16	47724	.203 (13/64)	45460, 45461, 45462, 45464, 45750, 45850, 45950, 45988, 54190, 54192, 54194.
3/8 x 5/8	47730	.203 (13/64)	45466.
1/2 x 23/32	47739	.234 (15/64)	45463, 45465, 45467, 45991.
1/2 x 25/32	47740	.234 (15/64)	45468, 45469, 45470, 45990, 45992, 51592, 57138, 57140, 57142, 57144.

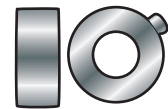

Retaining Collars

SOCKET HEAD ALLEN TYPE, TORX® AND PHILLIPS RETAINING SCREWS

CASE HARDENED • BLACK OXIDE FINISH

Type	Description	Tool No.	Use With Key Size	Application
Allen	3.5 x 6mm	67018	2.5mm (#5007)	RC-2000
Allen	3 x .5 x 10mm	67080	2.5mm (#5007)	'mini' bits
Allen	4 x .7mm x 12mm	67090	3mm (#5004)	20200 Adj. C/S
Allen	#10-32 x 3/8 NF	67093	5/32 (#5003)	Multi-Use
Allen	#5-40 x 1/2 NC	67094	3/32 (#5000)	Multi-Use
Allen	#3-48 x 3/8 NC	67095	5/64 (#5001)	Multi-Use
Allen	#5-40 x 3/8 NC	67096	3/32 (#5000)	Multi-Use
Allen	#10-32 x 1/2 NF	67109	5/32 (#5003)	Multi-Use
Torx®	4 x .7mm x 5mm	67115	#T-15 (#5005)	Torx® screw for insert trim & plunge bits
Torx®	3.5 x .6mm x 3mm	67117	#T-15 (#5005)	Torx® screw for insert plunge bits
Phillips	#2-56 x 7/32 NC	67134	#0 phillips	47090 & 47092 1/4 trim bits
Allen	#10-32 x 3/8 NF	67146	1/8 (#5009)	Special



Allen



Phillips



Torx®



ALLEN-TYPE SET SCREWS FLAT (FP) & CUP-POINT (CP)

CASE HARDENED • BLACK-OXIDE FINISH

Description	Tool No.	Use With Key Size	Application
5mm x .8mm (FP)	* 67007	*S/D Slotted	Boring Bits
6mm x 1.0mm (FP)	67008	3mm (#5008)	Rosette Cutterheads
3 x 4mm Special (FP)	67015	1.5mm (#5000)	RC-3100
3 x 5mm Special (FP)	67016	1.5mm (#5000)	RC-3200 & 3110
3 x 6mm Special (FP)	67017	1.5mm (#5000)	RC-3204 & 3307
6mm x 1.0mm (CP)	67079	3.0mm (#5004)	Metric Countersinks (6mm to 12mm)
6mm x 1.0mm (FP)	67083	3.0mm (#5004)	#55 Countersinks with 1 Screw
5mm x .8mm (CP)	67087	2.5mm (#5007)	Metric Countersinks (5mm only)
#5-40 NC (CP)	67091	1/16 (#5002)	47724-47752 Collars
#10-24 NC (CP)	67092	3/32 (#5000)	#55 Countersinks with 2 Screws
5mm x .8mm (FP)	67097	2.5mm (#5007)	Metric Chucks



Slotted



Allen



*#67007 Boring bit adjustment screw is screwdriver slotted.



Replacement Parts

REPLACEMENT PARTS

ALLEN-TYPE HEX & TORX® KEYS SHORT ARM

CASE HARDENED • BLACK OXIDE FINISH

Type	Size	Tool No.	Key Screw #(s)	Use With Application
Allen	3/32	5000	67094,67096	Multi-Use
Allen	5/64 (2.0mm)	5001	67095	Insert plunge
Allen	1/16	5002	67091	47724-47730, 47739 collars
Allen	5/32	5003	67093,67109	Helix trim & bowl bits
Allen	3mm	5004	67090	20200 Adj. C/S
Allen	.050 (1.2mm)	5006	67077	Insert plunge RC-2000
Allen	2.5mm	5007	67087,67097	Metric C/S & chucks
Allen	1/8	5009	67109	Solid surface bits
Allen	3mm	5012	67142	Insert Cutterheads
Allen	1.5mm	5011	67015,67016,67017	New insert bits RC-2000 & RC-3000 series
Allen	4mm	5010	67144	Profile Pro™ Cutterheads
Torx®	*T-25	5025	67154	61288, 61292



Allen



Torx®

TORX® & ALLEN KEY

CASE HARDENED • BLACK-OXIDE FINISH

Type	Key Size	Tool No.	Use With Screw #	Application
Torx®	#T-15	5005	67115	'RC' Series insert trim bits
Torx®	#T-9	5090	67160	Insert cutterheads
Allen	3 mm	5008	67008	Rosette Cutterheads-Hex Key



Allen



Torx®

HEX KEY / 'T'- HANDLE

CASE HARDENED • BLACK-OXIDE FINISH

Type	Key Size	Tool No.	Use With Screw #	Application
Allen	2.5mm	5013	—	Insert Cutterheads-T Handle
Allen	4mm	5014	67144	Insert Cutterheads-T Handle

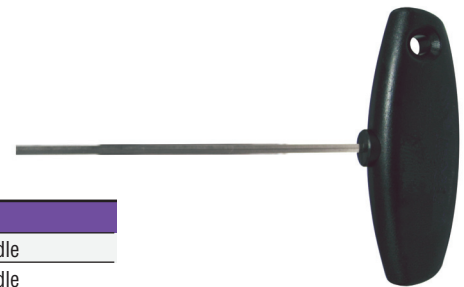

WRENCH HANDLE

CASE HARDENED • BLACK-OXIDE FINISH

Tool No.	Application
5017	EZ Dial™ Slot Cutters
5015	Nova System™ Router Bits



Torx® is a registered trademark of Camcar Div. of Textron.

Replacement Parts



10 PIECE BRASS TEMPLATE GUIDE SET

Includes 7 different guides, #ADP-09 adapter and 2 threaded lock collars in a molded plastic case.

Description	Tool No.
10 piece template guide set	BTG-100

Includes the following sizes:	
I.D.	O.D.
1/4	5/16
9/32	3/8
11/32	7/16
13/32	1/2
17/32	5/8
21/32	3/4
5/8	51/64



BRASS INLAY BUSHING

Includes both 3/16" & 9/16" O.D. for 1:1 ratio. Threaded lock collar included. Use #46200 1/8" down-cut spiral (not included).

Description	Tool No.
Inlay Bushing	BTG-200



9 PIECE ROUTER TEMPLATE GUIDE SET

Includes: Universal base plate, 5 different guides, lock ring, 2 centering pins and mounting screws in a molded plastic case.

Description	Tool No.
9-Piece Bushing Set	RGB-200

Includes the following sizes:	
I.D.	O.D.
1/4	5/16
3/8	7/16
17/32	5/8
3/8	7/16 (long)
17/32	5/8 (long)

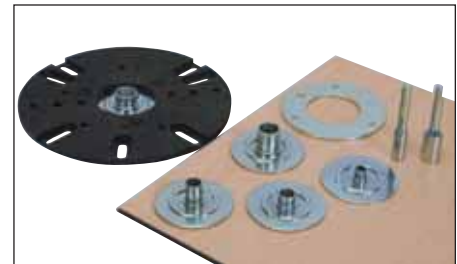

ROUTER SHANK REDUCTION BUSHINGS

ØD	Ød	Tool No.	L
1/4	3mm	RB-100	1
1/4	1/8	RB-102	1
8mm	6mm	RB-104	1
8mm	1/4	RB-106	1
3/8	1/4	RB-108	1
10mm	8mm	RB-110	1
12mm	6mm	RB-112	1
12mm	8mm	RB-114	1
1/2	1/4	RB-116	1
1/2	8mm	RB-118	1
1/2	10mm	RB-120	1
1/2	3/8	RB-122	1-3/16

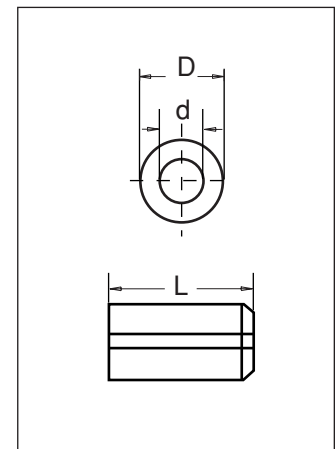

REPLACEMENT PARTS



Replacement Parts

STRAIGHT CARBIDE INSERT KNIVES

New grades now available for different material types such as softwood/hardwood, MDF/solid surface and micro-finish for general purpose. All knives have a 35° bevel, except the micro finish 'MF' series which has a 45° bevel.

REPLACEMENT PARTS

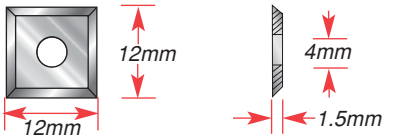
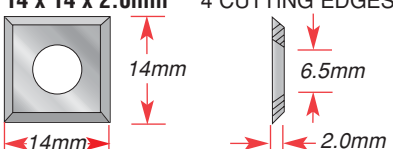
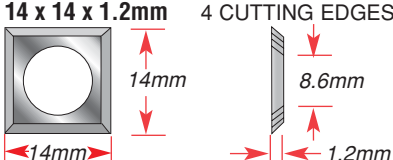
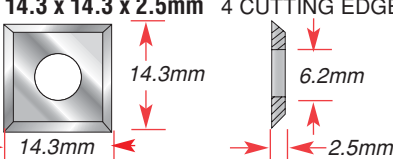
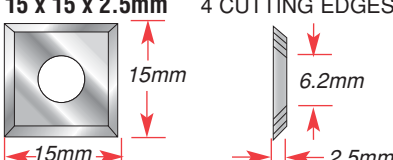
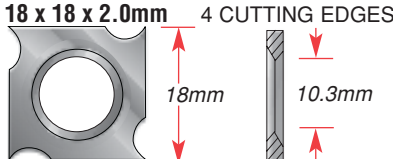
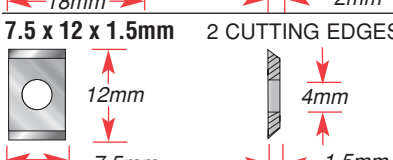
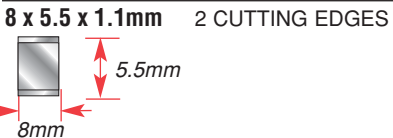
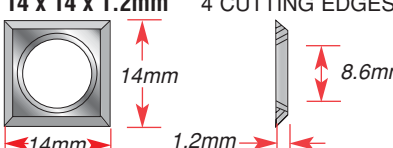
		'G' 35° General Purpose Wood, Chipboard, Plywood	'S' 35° Softwood/ Hardwood	'H' 35° MDF, Chipboard, Solid Surface	'MF' 45° Micro-finish General Purpose	Tool Application
12 x 12 x 1.5mm	4 CUTTING EDGES 	Tool # AMA-12	Tool # SMA-12	Tool # HMA-12	Tool # MFA-12	Insert Trim Bits RC-1000, RC-1008, RC-1010, RC-1012, RC-1014, RC-1024, RC-1026, RC-2257, RC-2258.
14 x 14 x 2.0mm	4 CUTTING EDGES 	Tool # RCK-70	Tool # SCK-70	Tool # HCK-70	—	Insert Cutterheads 61288, 61292, 61340, 61360, 61362, 61460, 61462, 61470, 61472, 61480, 61482.
14 x 14 x 1.2mm	4 CUTTING EDGES 	Tool # RCK-71	—	—	—	Insert Cutterheads 61330, 61350, 61450, 61452.
New 14.3 x 14.3 x 2.5mm	4 CUTTING EDGES 	Tool # RCK-73	—	—	—	Various
15 x 15 x 2.5mm	4 CUTTING EDGES 	Tool # RCK-15	—	—	—	Various
18 x 18 x 2.0mm	4 CUTTING EDGES 	Tool # RCK-18	—	—	—	Insert Cutterheads 61330, 61350, 61450, 61452.
7.5 x 12 x 1.5mm	2 CUTTING EDGES 	Tool # AMA-17	—	Tool # HCK-17	—	Insert Trim Bits RC-1040, RC-1042, RC-1044. Insert Cutterheads 61360, 61384.
New 8 x 5.5 x 1.1mm	2 CUTTING EDGES 	Tool # RCK-8	—	—	—	Use on RC-2000
New 14 x 14 x 1.2mm	4 CUTTING EDGES 	Tool # RCK-75	—	—	—	For Holz-Her System

Note: Knives shown actual size.

Replacement Parts



REPLACEMENT PARTS

	'G' 35° General Purpose Wood, Chipboard, Plywood	'S' 35° Softwood/ Hardwood	'H' 35° MDF, Chipboard, Solid Surface	'MF' 45° Micro-finish General Purpose	Tool Application
20 x 5.5 x 1.1mm 2 CUTTING EDGES 	Tool # RCK-32	—	—	—	Insert Straight Bit RC-3100.
30 x 5.5 x 1.1mm 2 CUTTING EDGES 	Tool # RCK-34	—	Tool # HCK-34	—	Insert Straight Bits RC-3110, RC-3200, RC-3204, RC-3260, RC-3300, RC-3305, RC-3310, RC-3312, RC-3318, RC-3320.
50 x 5.5 x 1.1mm 2 CUTTING EDGES 	Tool # RCK-36	—	Tool # HCK-36	—	Insert Straight Bits RC-3208, RC-3264, RC-3304, RC-3307, RC-3314, RC-3316, RC-3322, RC-3324.
30 x 9 x 1.5mm 4 CUTTING EDGES 	Tool # AMA-30	—	Tool # MDF-30	—	Insert Straight Bits RC-1080, RC-1082, RC-1154, RC-2080, RC-2082, RC-2154.
50 x 9 x 1.5mm 4 CUTTING EDGES 	Tool # AMA-50	—	—	—	Various
15 x 12 x 1.5mm 2 CUTTING EDGES 	Tool # ICK-15	—	Tool # HCK-15	—	Insert Cutterheads 61342, 61362, 61386.
20 x 12 x 1.5mm 2 CUTTING EDGES 	Tool # ICK-20	Tool # SCK-20	Tool # HCK-20	—	Insert Cutterhead 61388.
25 x 12 x 1.5mm 2 CUTTING EDGES 	Tool # AMA-25	—	Tool # HMA-25	—	Various
25 x 12 x 1.5mm 2 CUTTING EDGES 	Tool # ICK-25	—	Tool # HCK-25	—	Various

Note: Knives shown actual size.



Replacement Parts

REPLACEMENT PARTS

	'G' 35° General Purpose Wood, Chipboard, Plywood	'S' 35° Softwood/ Hardwood	'H' 35° MDF, Chipboard, Solid Surface	'MF' 45° Micro-finish General Purpose	Tool Application
30 x 12 x 1.5mm 2 CUTTING EDGES 	Tool # ICK-30	Tool # SCK-30	Tool # HCK-30	Tool # MFK-30	Insert Trim Bits RC-1002, RC-1004, and general use.
29.5 x 12 x 1.5mm 4 CUTTING EDGES 	Tool # RCK-30	Tool # SRK-30	Tool # HRK-30	—	Insert Straight Bits RC-1084, RC-1086, RC-1088, RC-1090, RC-1156, RC-1160, RC-1164, RC-2084, RC-2086, RC-2088, RC-2090, RC-2156, RC-2160, RC-2164.
50 x 12 x 1.5mm 2 CUTTING EDGES 	Tool # ICK-50	Tool # SCK-50	Tool # HCK-50	—	Insert Cutterheads 61304, 61306, . 61310
50 x 12 x 1.5mm 4 CUTTING EDGES 	Tool # RCK-50	Tool # SRK-50	Tool # HRK-50	—	Insert Cutterheads RC-1158, RC-1162, RC-1166, RC-2158, RC-2162, RC-2164.
30 x 12 x 1.5mm 2 CUTTING EDGES 	Tool # ICK-35RH	—	—	—	Edgebander trim knives, right hand.
30 x 12 x 1.5mm 2 CUTTING EDGES 	Tool # ICK-35LH	—	—	—	Edgebander trim knives, left hand.
New 50 x 12 x 1.7mm 4 CUTTING EDGES 	Tool # RCK-151	—	—	—	Use on RC-2400 Use on RC-1006